



SHINING 3D[®]

Aoralscan 3 Manual



V1.0.0.30



SHINING 3D[®]

Foreword

General

The Manual (hereinafter referred to as "the Manual") introduces the functions, installation, usage and maintenance of the Aoralscan 3 (hereinafter referred to as "the Scanner").

Safety Instructions

Signal	Meaning
	Additional information for particular situation.
	Improper actions or conditions that may damage the product or injury, and consequently void your warranty or service contract or lose the patient data or system data.
	The safety instructions that you must precisely follow in order to avoid injury. Failure to observe can cause damages to your product, or result in personal injuries, or even death.

Revision History

No.	Version	Revision Content	Release Date
1	V1.0.0.30	Add various types of operational safety precautions required by regulatory information.	August, 2021
2	V1.0.0.0	First release.	November, 2019

About the Manual

- Copyright ©2016 Shining3D Corporation. All rights reserved. No part of this publication may be reproduced, transmitted, transcribed, stored in a retrieval system or translated into any language or computer language, in any form or by any means, electronic, mechanical, magnetic, optical, chemical, manual or otherwise, without the prior written permission of Shining3D Corporation.
- All other logos, products, or company names mentioned in the Manual may be the registered trademarks or copyrights of their respective companies, and are used for informational purposes only.
- Shining 3D Tech Co., Ltd makes no representations or warranties, either expressed or implied, with respect to the contents hereof and specifically disclaims any warranties,

merchantability or fitness for any particular purpose. Further, Shining3D Corporation reserves the right to revise this publication and to make changes from time to time in the contents hereof without obligation of Shining3D Corporation to notify any person of such revision or changes.

- Updates to hardware and/or software components are made regularly; therefore, some of the instructions, illustrations, and specifications mentioned in the Manual may differ slightly from your particular situation.

Table of Contents

Foreword.....	- 1 -
1. Read This First	- 1 -
1.1. Basic Information	- 1 -
1.2. Intended Use	- 4 -
1.3. Contraindications	- 5 -
1.4. Warnings	- 5 -
1.5. Waste Electrical and Electronic Equipment	- 6 -
1.6. Disposal.....	- 6 -
1.7. Warranty	- 7 -
1.8. Contact Information	- 7 -
2. Safety Information	- 8 -
2.1. Precautions.....	- 8 -
2.2. Legend of Labels and Symbols.....	- 9 -
2.2.1. On the Scanner	- 10 -
2.2.2. On the Scanner/Carry Box/Package.....	- 10 -
2.3. Compliance.....	- 11 -
2.4. FCC Compliance Statement.....	- 11 -
2.5. Electrical Safety.....	- 11 -
2.5.1. Electrical	- 11 -
2.5.2. Classification.....	- 12 -
2.5.3. EMC Notice.....	- 13 -
2.6. Biological Safety	- 20 -
2.7. Laser Protection	- 20 -
3. Unpack the Package	- 22 -
4. Overview	- 24 -
4.1. Benefits of the Product	- 24 -
4.2. Scanner Overview.....	- 24 -

4.2.1.	Scan head and scanner body	- 24 -
4.2.2.	Scanner Pedestal.....	- 25 -
4.2.3.	Relay box.....	- 25 -
4.2.4.	Main Cables.....	- 26 -
4.3.	Software Overview	- 27 -
4.3.1.	System requirements.....	- 27 -
4.3.2.	Installing the software programs	- 28 -
5.	Setting the Scanner	- 29 -
5.1.	Connecting the Scanner	- 29 -
5.2.	Disconnecting the Scanner	- 30 -
5.3.	Calibrating the Scanner	- 30 -
6.	Scanning Preparations.....	- 33 -
6.1.	Intraoral Environment.....	- 33 -
6.2.	Scanner Preparation	- 33 -
6.3.	Scanning Position and Path.....	- 33 -
6.4.	Heating the Scanner Head	- 34 -
7.	Clinical Case Quick Guide.....	- 36 -
7.1.	Connect the Scanner.....	- 36 -
7.2.	Activate the Scanner	- 36 -
7.3.	Calibration	- 36 -
7.4.	Register Account	- 36 -
7.5.	Create Orders.....	- 36 -
7.6.	Scan Upper Jaw	- 37 -
7.7.	Scan Lower Jaw	- 38 -
7.8.	Scan Total Jaws	- 38 -
7.9.	View Result Data	- 40 -
7.9.1.	View Upper/Lower Jaw	- 40 -
7.9.2.	View Occlusal Effect	- 41 -

7.10.	Pre-Design	- 42 -
7.11.	View Data Storage Path.....	- 42 -
7.12.	Upload Order	- 42 -
8.	Care and Maintenance	- 43 -
8.1.	Pre-cleaning, Disinfection, and Sterilization.....	- 43 -
8.2.	Scanner Pedestal Care.....	- 44 -
8.3.	Scanner Body Care.....	- 44 -
8.4.	Scanner Head Care	- 46 -
8.4.1.	Cleaning and high-level disinfection	- 46 -
8.4.2.	Cleaning and steam sterilization	- 48 -
8.4.3.	Attaching the scanner head.....	- 49 -
8.5.	Scanner Storage	- 50 -
8.5.1.	Storage for Transport	- 50 -
8.5.2.	Daily and Long-term Storage	- 51 -
9.	Hardware Specification	- 52 -
9.1.	Specifications	- 52 -
9.2.	Environmental Requirements	- 52 -

1. Read This First

The Manual provides important procedures and information on how to operate the scanner and configure the IntraoralScan software correctly and safely. Before attempting to operate the product, read the Manual and strictly observe all warnings and cautions. Pay extra attention to the information from Safety information in chapter 2.

1.1. Basic Information

A. Product name, model

Product name: IntraoralScan

Model: Aoralscan 3

Name, residence, contact information and after-sales service of the registrant or the filer:

Registrant's name: SHINING 3D Tech Co., Ltd.

After-sales service provider: SHINING 3D Tech Co., Ltd.

Name, residence, contact information and after-sales service of the manufacturer

Manufacturer name: SHINING 3D Tech Co., Ltd.

Production Address: No. 1398, Xiangbin Road, Wenyan, Xiaoshan, Hangzhou, Zhejiang, China, 311258

Product performance, main structural composition

Product performance

- Appearance and structure

The appearance should be smooth, no cracks, no stains, no obvious deformation, flexible and reliable operating mechanism.

- Function control and display

Function control: After pressing the scanning button, determine whether the front end of the scanner flashes normally.

Display: Under normal working conditions, when the scanner is opened for scanning, the two-dimensional and three-dimensional imaging of the scanned object (such as teeth) can be seen on the display respectively.

3D image processing: After the 3D stereo image is generated, the 3D image can be cropped

as needed by using the relevant buttons on the top, bottom and right side.

- Performance

Posterior groove teeth scanning and imaging: Under normal operating conditions, the scanner can scan and image human posterior alveolar teeth to form a 3D digital model.

Irradiance: Under normal use of the intraoral scanner, the irradiance is not greater than 1mW/cm².

Accuracy: Under normal conditions, the scanner is used to scan against a standard (e.g., a plaster standard known to be similar in size to a tooth), obtain its three-dimensional stereoscopic data, and measure key dimensions to obtain measured values.

Heating of the entrance part of the scanning head: Under normal working conditions, the intraoral scanner should have heating and anti-fogging function when entering the mouth under working condition.

- Data interface

USB 3.0, data storage format shall include 3D digital model format .stl and .obj.

Main structural composition

The Scanner consists of Scanner body, scanner head, relay box, adapter, pedestal, USB cable, software (V1.0), and encryption module. The software carrier is USB flash drive, and the software release version is V1.0. After the power is switched on, ensure that the relay box and scanner are powered on. When the power is on, the relay box indicator is green.

Attention

- It is recommended that users copy the software from the USB flash drive to the computer hard disk before installing the driver.
- Use Nvidia graphics cards to get the highest scanning efficiency.
- Do not insert wireless USB network card in the computer, USB wireless network card will lead to USB bandwidth occupation, affecting the normal work of the camera.

VI. Product maintenance and care methods, special storage/transportation conditions, operating conditions.

1) The product does not work in the state as far as possible not to open, the need for water and moisture.

2) The need to use dustproof cover when sitting.

3) After using scanner head, use alcohol to wipe and then use autoclave to sterilize it. (121°C, 102.9kPa for 30 minutes; 134°C, 205.8kPa for 4 minutes). Use alcohol to wipe the scanner cover. Use dust-proof cloth to wipe the scanning window to ensure the window keeps dry.

4) Operating temperature: 10°C to 40°C, relative humidity: 30%–75%.

5) Storage/transport temperature: -25°C to 60°C, relative humidity: 30%–75%.

6) Air pressure: 86 kPa–106 kPa.

Note

The temperature and humidity and atmospheric pressure conditions for storage/transportation are reflected on the outer packaging.

VII. Production date, use by date or expiration date

The production date is shown on the product label. Use period: 8 years.

Eight, the list of accessories, including accessories, accessories, wear and tear replacement cycle and instructions on how to replace.

Scan head as a wear and tear products can be autoclaved up to 20 times, after which it needs to be replaced. Replacement method is as follows.

(1) Disconnect the scanner power, hold the scanning head firmly with thumb and index finger on both sides, and then gently slide the scanning head out of the scanner as shown in the figure.

(2) Hold the scan head firmly with your thumb and index finger on either side and gently attach the scan head to the scanner with the head facing down.

CAUTION

Do not place your fingers on the lens of the scan head when removing and attaching the scan head, because this might cause damage to the lenses.

(3) Try to gently shake the scan head to ensure that it locks into place and is stable.

CAUTION

The Aoralcan 3 intraoral scanner should not be used in close proximity or stacked with other equipment, and if it must be used in close proximity or stacked, observe to verify proper operation in the configuration in which it is used.

Class A equipment is intended for use in industrial environments where it may be potentially difficult to ensure electromagnetic compatibility in other environments due to conducted and radiated disturbances from the Aoralcan 3 intra-oral scanner.

The use of accessories and cables other than those specified may result in increased emissions or reduced immunity of the Aoralscan 3 intraoral scanner, except for cables sold by the manufacturer of the Aoralscan 3 intra-oral scanner as spare parts for internal components.

Interruptions during electrostatic testing can be recovered within 5s without affecting basic performance.

1.2. Intended Use

This is an intraoral scanner that works with the supplied software programs. With Intraoral Scanner, you can perform intraoral scanning directly and digitally acquire and save the 2D/3D color images of a patient's teeth and gingiva for the orthodontic, implant, and restoration use. The scanner kit is composed of: Scanner head, scanner body, pedestal, power adapter, USB cable, relay box, USB flash drive (with IntraoralScan software inside, V1.0) and dongle.

Note:

- Benefits to be achieved: As a device that applies a probing optical scanning head, this scanner can directly scan inside the patient's mouth to obtain three-dimensional morphology and color texture information of soft and hard tissue surfaces such as teeth, gums, and mucous membranes in the oral cavity, facilitating comfortable mold taking for patients, reducing stress for medical care, and improving efficiency for back-end processing.
- The scanner satisfies **CE** related requirements.

WARNINGS

- Do not use the scanner for purposes other than those intended and expressly stated above.
- This product is designed and intended for use by persons with professions of dentistry and dental laboratory technology. The product cannot be operated by the patients themselves. The user is solely responsible for determining whether the scanner is appropriate for a particular patient case.
 - Do not misuse the scanner, and do not use or operate the software programs incorrectly.
 - The clinical environments where the scanner and the software programs can be used include dental clinics, dental hospitals, and dental laboratories.
 - Only trained medical personnel may use the scanner and the supplied software programs.

- Installation, use, and operation of the scanner are subject to the law in the jurisdictions in which it is used. Install, use, and operate the scanner only in such ways that do not conflict with applicable laws or regulations, which have the force of law. Use of the scanner for purposes other than those intended and expressly stated here, as well as incorrect use or operation, may relieve us or our agents from all or some responsibilities for resultant noncompliance, damage, or injury.

- The users of this scanner and software are responsible for image quality and diagnosis. They should ensure that the inspection data is being used for the analysis and diagnosis only, and furthermore the data is sufficient both spatially and temporally for the measurement approach being used.

- The images acquired by the scanner must be interpreted by a qualified medical professional. The software in no way interprets these images or provides a medical diagnosis of the patient being examined.

1.3. Contraindications

No known contraindications.

1.4. Warnings

Before using the Aoralcan 3, read these warnings and Safety information on chapter 2.

- Do not attempt to disassemble, repair, or modify the scanner and software.
- There are no user serviceable parts inside the scanner. Necessary modifications must be made only by the manufacturer or its designated agents.
- Do not allow foreign objects (including all types of liquids) to enter the scanner and its pedestal. Water, moisture, etc. may cause a short circuit in the electronic components and lead to malfunction.
- If the scanner head is accidentally dropped to the ground, check to make sure the lens is not loose before using it.
- If the scanner is inadvertently dropped on the ground or impacted, it must be calibrated before use. If there are still accuracy problems or scanning abnormalities after calibration, please consult technical support.
- Do not drop or apply shock/vibration to this scanner and its pedestal. Strong impacts may damage the components inside.
- Do not cut, bend, modify, place heavy objects, or step on the cables. Otherwise, the external insulation may be damaged and result in short-circuit or fire.

- To avoid electrical shock, use only supplied power adapter and connect it only to properly grounded wall outlets.
- The device should not be used adjacent to or stacked with other equipment. If adjacent or stacked use is necessary, the device should be observed to verify normal operation in the configuration in which it will be used.

1.5. Waste Electrical and Electronic Equipment

Disposal of Waste Electrical and Electronic Equipment and by users in private households in the European Union.

This symbol on the product or on the packaging indicates that this cannot be disposed of as household waste. You must dispose of your waste equipment by handing it over to the applicable take-back scheme for the recycling of electrical and electronic equipment and/or battery. For more information about recycling of this equipment, contact your city office, the shop where you purchased the equipment or your household waste disposal service. The recycling of materials will help to conserve natural resources and ensure that it is recycled in a manner that protects human health and environment.



1.6. Disposal



The scanner must be reprocessed prior to disposal in order to prevent cross-contamination.

All electrical and electronic devices must be disposed of separately from your other household waste in order to promote reuse, recycling and other forms of recovery, to prevent any potential adverse effects of hazardous substances on the environment and human health, and also to reduce the amount of waste in landfill. This includes accessories such as power adapters, power cords, etc. Do safely dispose of the device and its accessories in accordance with applicable laws and regulations.

For specific information on disposal of your device and the packaging, contact your local distributor or service provider.

1.7. Warranty

The warranty is void if unauthorized personnel perform service or maintenance on the set of Aoralscan 3. To ensure correct product performance and to obtain warranty service, contact technical support.

1.8. Contact Information

Manufacturer

Shining 3D Tech Co., Ltd

No.1398, Xiangbin Road, Wenyan, Xiaoshan, Hangzhou, Zhejiang, China

www.shining3d.com

Customer Support

Email: dental_support@shining3d.com

Shining 3D's Representative

Lotus NL B.V.

Address: Koningin Julianaplein 10,1e Verd,2595AA,The Hague, Netherlands.

Telephone: +31644168999

Email: peter@lotusnl.com

2. Safety Information

2.1. Precautions

Warning

Follow the procedures carefully and ensure that the power/electrical/environmental requirements are satisfied. Failure to observe the instructions or disregard the warnings may result in damages to the product, personal injury, or even death of the user or the patient.

- Do not use the hardware and software for any application until you have read, understood, and known all the safety information, safety procedures, and emergency procedures contained in this chapter. Operating the hardware and software without a proper awareness of safe use could lead to fatal damage to the hardware or permanent data loss.

- Ensure that the connection is performed correctly by following the instructions given in Connecting the scanner in chapter 4.

- Use only medical grade devices with the scanner in the patient environment.

- The hardware and software should only be used in a medical facility under the supervision of trained personnel.

- Only authorized service labs should perform maintenance. It is expressly prohibited to open the scanner with tools.

- The hardware and software have been fully adjusted and tested prior to shipment from the factory. Unauthorized modifications will void your warranty.

- If the hardware or software is modified, appropriate inspection and testing must be conducted to ensure continued safe use.

- Check the scanner and components for sharp edges.

- Before use, check the device for damage, loose parts, wear and tear, and other cosmetic problems. In case of such problems, please contact after-sales service.

- During use, always pay attention to abnormal conditions of the scanner and the patient. In case of abnormal conditions, you need to stop using it immediately. Consult technical support staff promptly.

- To ensure the performance and safety of the scanner, use only the original accessories provided with the scanner (or accessories specified by Shining 3D, consult technical support for details) and software.

- Use only supplied accessories and approved software with the scanner in order to

achieve the designed performance.

- Do not use a power adapter other than the one supplied with the package.
- Connecting the scanner to an unknown power adapter is very dangerous and may lead to fire or explosion.
- Using cables or accessories other than those specified for use with the scanner may result in increased emissions or decreased immunity of the device.
- The supplied medical grade power adapter should only be connected to a grounded power socket.
- Reasonably Arrange communication cables, power lines and other types of cables to prevent users or patients from tripping over the wires. Do not forcibly pull or bend cables of any kind.
- The scanner is not intended for use in environments with high concentrations of flammable liquids, gases, or atmospheric oxygen.
- There is a risk of explosion when the scanner is used around flammable anesthetics.
- Do not connect USB peripherals with an extended USB cable. Extended connection may cause unexpected usage fault.
- Always handle the scanner with care and avoid hitting or scratching the surfaces as it contains fragile components. Dropping the scanner on the floor may cause permanent damage. If you accidentally drop the scanner, you MUST dispose the scanner head immediately and do not use the same head again. The mirror in the head might shatter into small pieces, and using it again poses the highest risk of causing serious injury to the user and patient.
- The scanner might heat up to above the normal body temperature, yet this short- term exposure and contact with small areas will not pose a health or safety hazard to the patient.
- The scanner may interfere with pacemakers and ICDs, and use of the scanner on patients with pacemakers and ICDs is prohibited.
- Never place any objects or load on the scanner and its pedestal.
- Do not dispose the scanner as unsorted municipal waste. The scanner must be collected separately and disposed of in accordance with the local laws and regulations. For proper disposal of this scanner, contact your local representative of Shining3D Corporation.

2.2. Legend of Labels and Symbols

The following symbols provide information on the product's labels and regulatory compliance.

2.2.1. On the Scanner

Specification for scanner serial number

Serial number AOS3-AH001K13 represents the 001 product manufactured on November 13, 2018.

- AOS3.....Stands for scanner model, abbreviation for Aoralscan 3.
- AH.....Represents the year of production, A – J in alphabetical order stands for 1: 9 (Since letter I and number 1 are easily confused, ignore I), and 0 is represented by the letter X.
- 001.....On behalf of the production flow number, unit 1.
- K.....On behalf of the month, by letter A-M for 1-12 (Since letter I and number 1 are easily confused, ignore I).
- 13.....Represents the date, expressed in 01 - 31.





Specification for serial number of calibrator









Serial number iCIII-AH001L05 represents the 001 product produced on December 05, 2018.

- iCIII.....Represents the model of the calibrator.
- AH.....Represents the year of production, A to J in alphabetical order stands for 1:9 (Since letter I and number 1 are easily confused, ignore I), and 0 is represented by the letter X.
- 001.....On behalf of the offline water number.
- LOn behalf of the month, by letter A-M for 1-12 (Since letter I and number 1 are easily confused, ignore I).
- 05.....Represents the date, expressed in 01 - 31.

2.2.2. On the Scanner/Carry Box/Package

Labels and symbols on the carry box/package

Symbol	Explanation
	General warning – caution.
	Indicates that the device complies with requirements for the BF type applied part according to IEC 60601-1, providing protection against electric shock.
	Indicates that the contents of the transport package are fragile and therefore shall be handled with care.
	Indicates that the transport package shall be kept dry.

	Indicates correct upright position of the transport package.
	Indicates that the material shall be recycled.
	Indicates the manufacturer information.
	Indicates the product serial number information.
	Indicates CE-related certification information.
	Class II equipment.
	Indicates laser information.
	Indicates Shining 3D's representative information.
	Indicates that for more information, see use manual.

2.3. Compliance

Anyone creating or changing a medical electrical system through a combination with other devices in accordance with standard EN 60601-1-1:2001 based on 60601-1-1:2000 (specification for the safety of medical electrical systems)/UL 60601-1 Part 1: first edition 2003 is responsible for ensuring that the requirements of these standards are met to the full extent in order to ensure the safety of patients, operators and the environment.

2.4. FCC Compliance Statement

This device complies with part 15 of the FCC Rules. Operation is subject to the following two conditions: (1) This device may not cause harmful interference, and (2) this device must accept any interference received, including interference that may cause undesired operation.

2.5. Electrical Safety

Only trained medical personnel should operate this scanner. The product complies with the following standards.

2.5.1. Electrical

- IEC 60601-1-2: 2014 Medical electrical equipment Part 1-2: General requirements for

basic safety and essential performance-Collateral Standard: Electromagnetic disturbances– Requirements and tests

- IEC 60601-1: 2015/A1: 2012 (ed 3.1) Medical electrical equipment – Part 1: General requirements for basic safety and essential performance

- IEC 60601-1-6: 2013.Con Ed 3.1 Rev. October 29. 2013. Medical electrical equipment – Part 1-6: General requirements for basic safety and essential performance – Collateral standard: Usability

- IEC 62366-1: 2015 Medical devices–Part 1: Application of usability engineering to medical devices

2.5.2. Classification

- Type of protection against electric shock: Class II
- The degree of protection against electric shock: Type BF
- Enclosure protection: IPX0
- Degree of protection against incoming liquids: Common device.
- Level of safety when used with flammable anesthetic gas mixed with air or flammable anesthetic gas mixed with oxygen or nitrous oxide: Non-AP/APG equipment.
- The mode of operation: Continuous operation
- Pollution degree 2

WARNINGS

- Shock hazards exist if the power adapter is damaged or is not properly grounded. Use only the supplied medical grade power adapter.
- To meet waterproof requirements, the sockets should not be placed on the ground.
- Do not use grounding type plugs for other purposes.
- Only authorized service labs can make internal replacements of the scanner and modify the software.
- Do not use the scanner if its head or cable is damaged. Contact technical support for replacement of the damaged equipment (see Contact information on chapter 1).
- To avoid risk of electrical shock hazards, always inspect the scanner and cable connections before use.
- Check the cable housing before use. Do not use the scanner if the housing is damaged or the cable is abraded.
- All devices connected to the **Aoralscan 3** shall comply with IEC 60601-1 and IEC 60950.

- The radiation characteristics of the scanner are suitable for industrial and hospital use. (CISPR 11 Class A). If the Aoralscan system is used in a residential environment (CISPR 11 Class B), it may not adequately protect RF communications.

2.5.3. EMC Notice



Caution

- Aoralscan 3 meets the EMC requirements.
- Users should install and use the emc information provided in the random file.
- Aoralscan 3 might affect the performance of a portable or mobile RF communication device. Avoid strong ELECTROMAGNETIC interference when using a scanner, such as near a mobile phone or microwave oven.
- The guidance and manufacturer's statement are shown in the attached table.



Warning

- Aoralscan 3 should not be used in proximity or on top of other devices. If it must be, observe to verify that it works properly in the configuration in which it is used.
- This device is not intended for use in residential environments, which may not provide adequate protection for radio reception.
- With the exception of cables sold by the manufacturer of Aoralscan 3 as spare parts for internal components, the use of accessories and cables other than those specified may result in an increase in transmission power or a decrease in immunity of Aoralscan 3.

Electromagnetic Emissions

Medical electrical equipment such as the **Aoralscan 3** requires special precautions regarding electromagnetic compatibility, and must be installed and put into service according to the following electromagnetic tables.

The **Aoralscan 3** is intended for use in the electromagnetic environment specified below. The customer or user of the **Aoralscan 3** should assure that it is used in such an environment.

Guidance and Manufacturer's Statement - Electromagnetic emission		
Aoralscan 3 is intended to be used in the following electromagnetic environment. The purchaser or user of Aoralscan 3 should ensure that it is used in this electromagnetic environment:		
Emission Measurement	Conformity	Electromagnetic Environment - Guidelines

RF emissions CISPR 11	Group 1	The Aoralscan 3 uses RF energy only for its internal function. Therefore, its RF emissions are very low and are not likely to cause any interference in nearby electronic equipment.
RF emissions CISPR 11	Class A	The Aoralscan 3 is suitable for use in all establishments, including domestic establishments and those directly connected to the public low-voltage power supply network that supplies buildings used for domestic purposes.
Harmonic emissions IEC 61000-3-2	Class A	
Voltage fluctuations/flicker according IEC 61000-3-3	Complies	

Guidance and manufacturer's declaration–electromagnetic emissions

Interference immunity

The **Aoralscan 3** is intended for use in the electromagnetic environment specified below. The customer or user of the **Aoralscan 3** should assure that it is used in such an environment.

Guidance and Manufacturer's Statement - Electromagnetic emission			
Aoralscan 3 is intended to be used in the following electromagnetic environment. The purchaser or user of Aoralscan 3 should ensure that it is used in this electromagnetic environment:			
Immunity test	IEC 60601 test levels	Compliance level	Electromagnetic environment–guidance
Electrostatic discharge (ESD) IEC 61000-4-2	±8 kV contact ±2, ±4, ±8, ±15 kV air	±8 kV contact ±2, ±4, ±8, ±15 kV air	Floors should be wood, concrete or ceramic tile. If floors are covered with synthetic material, a relative humidity of at least 30% is recommended.
Electrical fast transient/burst IEC 61000-4-4	±2 kV for power supply lines	±2 kV for power supply lines	Mains power quality should be that of a typical commercial or hospital environment.
Surge IEC 61000-4-5	±0.5, ±1 kV line(s) to line(s)	±0.5, ±1kV differential mode	Mains power quality should be that of a typical commercial or hospital environment.

Immunity test	IEC 60601 test levels	Compliance level	Electromagnetic environment–guidance
Voltage dips, short interruptions and voltage variations on power supply input lines IEC 61000-4-11	0% U_T (100% dip in U_T) for 0.5/1 cycle 70% U_T (30% dip in U_T) for 25/30 cycles (for 0.5 sec) 0% U_T (100% dip in U_T) for 250/300 cycles (for 0.5 sec)	0% U_T (100% dip in U_T) for 0.5/1 cycle 70% U_T (30% dip in U_T) for 25/30 cycles (for 0.5 sec) 0% U_T (100% dip in U_T) for 250/300 cycles (for 0.5 sec)	Mains power quality should be that of a typical commercial or hospital environment. If the user of the Aoralscan 3 requires continued operation during power mains interruptions, it is recommended that the Aoralscan 3 be powered from an uninterruptible power supply or a battery.
Power frequency (50/60 Hz) magnetic field IEC 61000-4-8	30 A/m	30 A/m	Power frequency magnetic fields should be at levels characteristic of a typical location in a typical commercial or hospital environment. If image distortion occurs, it may be necessary to position the Aoralscan 3 further from sources of power frequency magnetic fields or to install magnetic shielding. The power frequency magnetic field should be measured in the intended installation location to assure that it is sufficiently low.
NOTE: U_T is the a.c. mains voltage prior to application of the test level.			

Guidance and manufacturer's declaration–electromagnetic immunity

Guidance and Manufacturer's Statement - Electromagnetic emission

Aoralscan 3 is intended to be used in the following electromagnetic environment. The purchaser or user of Aoralscan 3 should ensure that it is used in this electromagnetic environment:

Immunity test	IEC 60601 test levels	Compliance level	Electromagnetic environment – guidance
Conducted RF	3 Vrms 150 kHz to 80 MHz outside ISM bands	3 Vrms	Portable and mobile RF communications equipment should be used no closer to any part of the Aoralscan , including cables, than the recommended separation distance calculated from the equation appliance to the frequency of the transmitter. Recommended separation distance: $d = 1.2 \sqrt{P}$

<p>IEC 61000-4-6 Radiated RF</p>	<p>6 Vrms ISM bands between 150 kHz and 80 MHz</p>	<p>6 Vrms ISM bands between 150 kHz and 80 MHz</p>	<p>IEC 60601-1-2: 2014 $d = 1.2 \sqrt{P}$ 80 MHz to 800 MHz $d = 2.3 \sqrt{P}$ 800 MHz to 2.5 GHz IEC 60601-1-2: 2014 $d=2.0 \sqrt{P}$ 80 MHz to 2.7 GHz</p> <p>Where P is the maximum output power rating of the transmitter in watts (W) according to the transmitter manufacturer and d is the recommended separation distance in meters (m).</p>
<p>IEC 61000-4-3</p>	<p>80 MHz to 2.7 GHz 3V/m</p>	<p>3 V/m</p>	<p>Field strengths from fixed RF transmitters, as determined by an electromagnetic site survey^a, should be less than the compliance level in each frequency range^b. Interference may occur in the vicinity of equipment marked with following symbol:</p> 

Guidance and manufacturer’s declaration–electromagnetic immunity

<p>Guidance and Manufacturer's Statement - Electromagnetic emission</p>			
<p>Aoralscan 3 is intended to be used in the following electromagnetic environment. The purchaser or user of Aoralscan 3 should ensure that it is used in this electromagnetic environment:</p>			
<p>Immunity test</p>	<p>IEC 60601 test levels</p>	<p>Compliance level</p>	<p>Electromagnetic environment – guidance</p>
<p>NOTE 1: At 80 MHz and 800 MHz, the higher frequency range applies. NOTE 2: These guidelines may not apply in all situations. Electromagnetic propagation is affected by absorption and reflection from structures, objects and people.</p>			

^a Field strengths from fixed transmitters, such as base stations for radio (cellular/ cordless) telephones and land mobile radios, amateur radio, AM and FM radio broadcast and TV broadcast cannot be predicted theoretically with accuracy. To assess the electromagnetic environment due to fixed RF transmitters, an electromagnetic site survey should be considered. If the measured field strength in the location in which the **Aoralscan 3** is used exceeds the applicable RF compliance level above, the **Aoralscan 3** should be observed to verify normal operation. If abnormal performance is observed, additional measures may be necessary, such as reorienting or relocating the **Aoralscan 3**.

^b Over the frequency range 150 kHz to 80 MHz, field strengths should be less than 3 V/m.

^c The ISM (industrial, scientific and medical) bands between 150 kHz and 80 MHz are 6.765 MHz to 6.795 MHz; 13.553 MHz to 13.567 MHz; 26.957 MHz to 27.283 MHz; and 40.66 MHz to 40.70 MHz.

Guidance and manufacturer’s declaration–electromagnetic immunity

To limit exposure to electromagnetic interference from nearby equipment that can degrade image quality or launch warning messages, it is necessary to position the **Aoralscan 3** further from sources of electromagnetic interference or install electromagnetic shielding to block unwanted interference. The customer or the user of the **Aoralscan 3** should operate the device under EMI conditions that minimize power supply transients, mechanical interactions, vibration, and thermal, optical, and ionizing radiation.

Separation distances

The **Aoralscan 3** is intended for use in the electromagnetic environment in which radiated RF disturbances are controlled. The customer or the user of the **Aoralscan 3** can help prevent electromagnetic interference by maintaining a minimum distance between portable and mobile RF communications equipment (transmitters) and the **Aoralscan 3** as recommended below, according to the maximum output power of the communications equipment.

Guidance and Manufacturer's Statement - Electromagnetic emission	
Aoralscan 3 is intended to be used in the following electromagnetic environment. The purchaser or user of Aoralscan 3 should ensure that it is used in this electromagnetic environment:	
Rated maximum output power of transmitter (W)	Separation distance according to frequency of transmitter (m)
	IEC 60601-1-2: 2014

	150 kHz to 80 MHz $d = 1.2 \sqrt{P}$	80 MHz to 800 MHz $d = 1.2 \sqrt{P}$	800 MHz to 2.5 GHz $d = 2.3 \sqrt{P}$
0.01	0.12	0.12	0.23
0.1	0.38	0.38	0.73
1	1.2	1.2	2.3
10	3.8	3.8	7.3
100	12	12	23
<p>For transmitters rated a maximum output power not listed above, the recommended separation distance d in meters (m) can be estimated using the equation applicable to the frequency of the transmitter, where P is the maximum output power rating of the transmitter in watts (W) according to the transmitter manufacturer.</p>			
<p>NOTE 1: At 80 MHz and 800 MHz, the separation distance for the higher frequency range applies.</p> <p>NOTE 2: These guidelines may not apply in all situations. Electromagnetic propagation is affected by absorption and reflection from structures, objects and people.</p>			

Table 2-5 Recommended separation distances between portable and mobile RF communications equipment and the **Aoralscan 3**

The medical electrical equipment is suitable for the professional healthcare environment per 60601-1-2:2014. It is suitable for use in physician offices, clinics, hospitals, and other professional healthcare environments except near HF surgical equipment and the RF shielded room of an ME system for magnetic resonance imaging or other environments where the intensity of electromagnetic disturbances is high.

The clinical environments where the device can be used include physician offices, clinics, hospitals, and clinical point-of-care for diagnosis of patients except environments where the intensity of electromagnetic disturbances is high.



WARNINGS

- Using accessories outside Shining3D provisions might lead to increased electromagnetic emissions, or electromagnetic immunity reduced.
- Portable RF communications equipment (including peripherals such as antenna cables and external antennas) should be used no closer than 30 cm (12 inches) to any part of the Aoralscan 3, including cables specified by the manufacturer. Otherwise, degradation of the

performance of this equipment could result.

- If higher IMMUNITY TEST LEVELS than those specified in IEC60601-1-2.
- The minimum separation distance may be lowered. Lower minimum separation distances shall be calculated using the equation specified in IEC60601-1-2 Chapter 8.10.
- WARNING: Use of this equipment adjacent to or stacked with other equipment should be avoided because it could result in improper operation.
- WARNING: Use of accessories, transducers and cables other than those specified or provided by the manufacturer of this equipment could result in increased electromagnetic emissions or decreased electromagnetic immunity of this equipment and result in improper operation.
- Note The EMISSIONS characteristics of this equipment make it suitable for use in industrial areas and hospitals (CISPR 11 class A). If it is used in a residential environment (for which CISPR 11 class B is normally required) this equipment might not offer adequate protection to radio-frequency communication services. The user might need to take mitigation measures, such as relocating or re-orienting the equipment.

2.6. Biological Safety

Meets biological criteria: ISO10993-5: 2009 (Biological evaluation of medical devices — Part 5: Tests for in vitro cytotoxicity); ISO10993-10: 2010 (Biological evaluation of medical devices — Part 10: Tests for irritation and skin sensitization).

2.7. Laser Protection

This product is a class 1 laser product and is only for maintenance, replacement and removal by professional personnel of the manufacturer or its designated agent (if necessary). If the device is not used, removed or replaced as required, the normal use of the device may be affected and laser radiation may occur. If a laser component is faulty, contact the manufacturer for help.

This product is a class 1 laser product according to "IEC 60825-1:2014 Safety of laser products- Part 1: Equipment classification and requirements", without harmful laser radiation. Users will not be exposed to laser radiation if they operate the equipment correctly according to the instructions.

Users should be aware of optical radiation protection. Bright light is projected from the scanning head during scanning. As with other light, there may be a temporary reduction in vision or visual residuals. Do not look directly into the light projected by the scanning head or shine the light into the eyes of others.

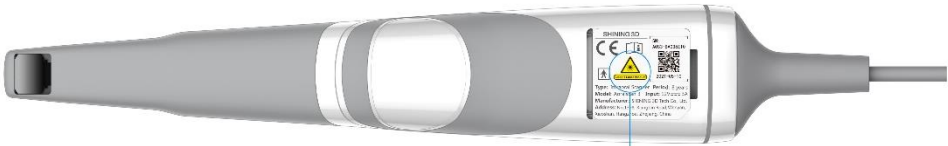

Laser Class Label
Class 1 Laser Product



3. Unpack the Package

Check the carry box for the following items. If any item is missing or damaged, contact the distributor or service provider immediately.

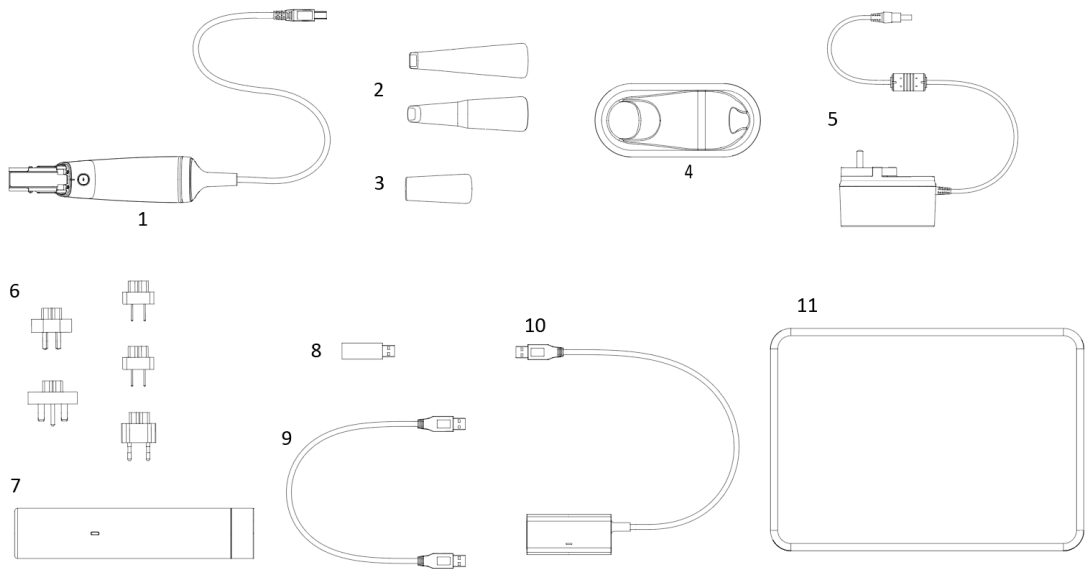

1. 1 x Intraoral Scanner with a USB 3.0 cable (length: 2m)
2. 1 x protection cap
3. Scanner heads (4 standard scanner heads and 1 small scanner head)
4. 1 x scanner pedestal
5. 1 x AC/DC power adapter (input: 100-240 V, 50-60 Hz, 1.0 A; output: 12 V DC, 3 A; power cord length: 1.5 m)
6. 5 x power cord plugs
7. 1 x calibrator
8. 1 x USB flash drive (the software carrier)
9. 1 x USB 3.0 cable. Use it together with the calibrator.
10. 1 x relay box
11. 1 x package box

WARNINGS

- AC plug types vary by country/region.
- Using accessories, peripherals, or cables not supplied with the product or recommended by Shining3D Corporation can affect the device in the form of increased emissions or decreased

immunity to external EMI/EMC occurrences. Non-specified peripherals, and cables in some cases, can also increase leakage current or compromise the safety of the grounding scheme.

- Using accessories or power supply units other than those specified may cause the warranty to void and result in increased emissions, decreased EMI immunity of the device, or even damages to the device and personal injuries.

- Use of other accessories results in non-compliance.
- Place the USB flash drive in a safe place for later use.

NOTE

We recommend that you keep all the original packaging components in a safe place in case you need to transport or dispose of the scanner in the future.

4. Overview

4.1. Benefits of the Product

The **Aoralscan 3** is designed to provide powder-free intraoral color scanning, with higher speeds bringing greater accuracy and less time-lag for image acquisition. It can be used to scan a single tooth, multiple teeth, and whole dental arches. The captured 3D digital images of teeth and soft-tissue areas are designed to be used in conjunction with the supplied software programs. Dental Order System Module, which helps manage the patient information and scanned records, and Scan module, which assists you in acquiring digital images, and supports scan data export (in STL/OBJ format) to CAD/CAM systems for different purposes of dental care.

4.2. Scanner Overview

4.2.1. Scan head and scanner body

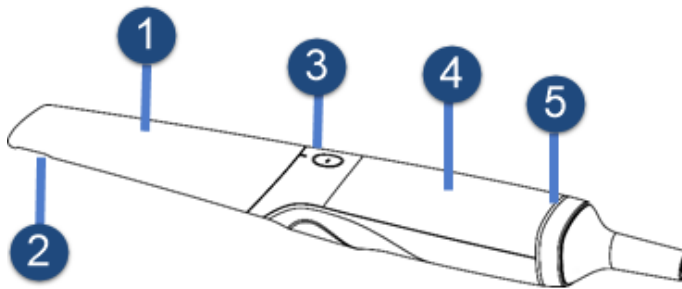

No.	Item	Description
1	Scanner head	Use the scanner head to scan the upper, lower or full jaw. The scanner head can be autoclaved for 30 times.
2	Heating device	The heating device ensure successful scanning by preventing fogging on the lens.
3	Scan button	Single press to start scanning and pause scanning; long press to proceed to the next step; double click to start the motion sensing function.
4	Scanner body	Rotate the scanner body during scanning to obtain the best scanning angle. During the scanning process, the scanner body may heat up, but the temperature will not cause harm to users and patients.

5	Indicator light	<p>Indicates the status of the scanner.</p> <ul style="list-style-type: none"> ● Flashing green: The scanner is in the connection or warm-up phase. ● Green: The scanner is in scanning or standby mode. ● Blue: The stitching is unsuccessful when the scanner is scanning. ● Breathing green: The scanner is in sleep mode.
---	-----------------	---

4.2.2. Scanner Pedestal

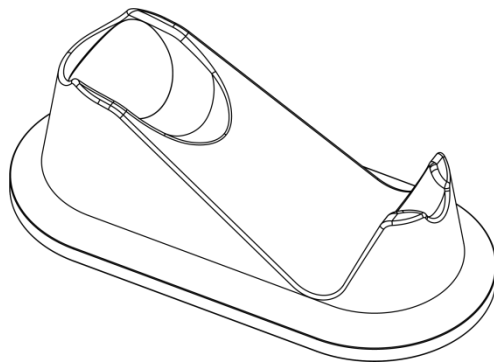

Item	Description
Scanner pedestal	When the scanner is not in use, place it on the pedestal.

Notes:

- If the scanner is idle for more than 1 minute, it will automatically enter the standby mode. When the scanner is idle for more than 3 minutes (such as on the pedestal), it will enter the sleep mode, and the indicator light on the scanner body will also be in the breathing light state.

- As long as there is power connected to scanner, the scanner head will be heated even if the scanner is in standby or sleep mode.

4.2.3. Relay box

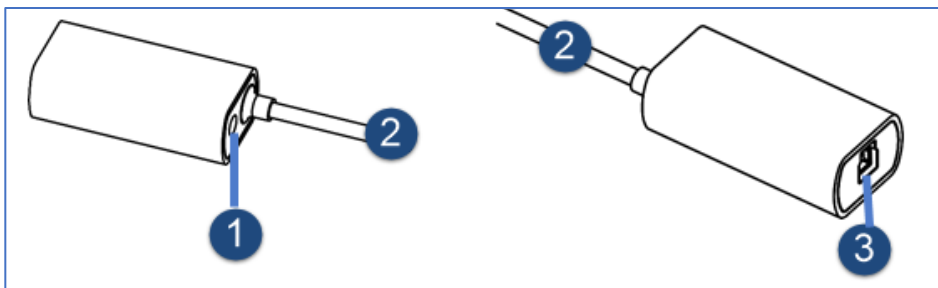

Item	Description
Relay Box	<ol style="list-style-type: none"> 1. Power socket. 2. Data cable, the other end is connected to the USB3.0 port of the computer. 3. Port to which the scanner should be connected.

USB cable storage

To prevent the USB cable from getting damaged by excessive bending or twisting, you should loosely coil the cable and avoid making kinks or sharp bends.

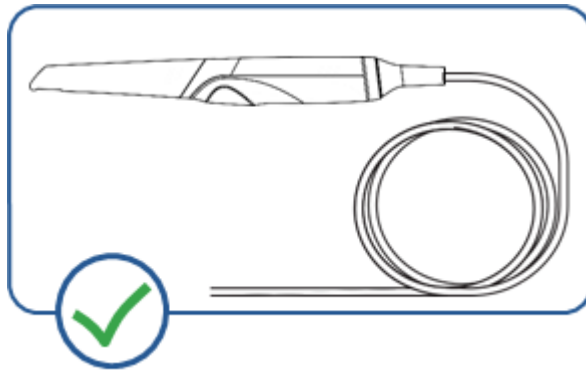

CAUTION

Do NOT roll the cable over the handle of the scanner or even bend the cable sharply. The illustration below demonstrates improper cable storage.

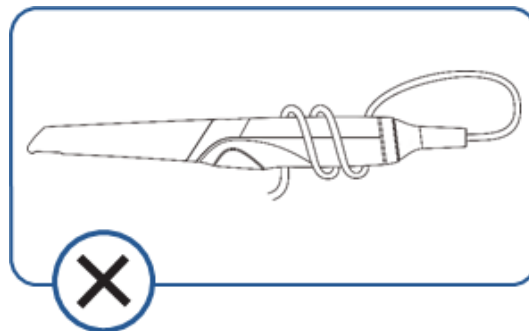

4.2.4. Main Cables

See the table for main cables.

No.	Name	Length (m)
1	Adapter 1 power cable	1.5
2	Adapter 2 power cable	1.5
3	Relay box data cable (USB 3.0)	1.0

4.3. Software Overview

The **Aoralscan 3** is designed to operate with the software programs, which include four modules:

- Calibration module

Calibrate the scanner.

- Dental order system module

Designed to manage and store patient data, including cases, prescriptions, and restoration information, realizing functions such as order creation, editing, searching, scanning and deletion, as well as uploading, downloading, previewing and tracking of scanned order and data.

- Scan module

The interface guides you through the entire scanning process of acquiring intraoral digital images with the scanner.

- Pre-design module

Mainly for the user to be more convenient to use in the design software, can realize coordinate adjustment, mark tooth position, extraction edge line and other functions.

4.3.1. System requirements

Before installing and running the supplied software programs, your computer shall meet the following requirements:

CPU	Intel Core i7-8700 or higher
Memory	16 GB or higher
Hard disk drive	256 GB SSD or above
Graphic card (GPU)	NVIDIA RTX 2060 6GB or higher
Operating system	Windows 10 Professional (64-bit) or later versions of Windows operating system
Display Resolution	1920X1080, 60Hz or higher
I/O ports	More than 2 type-A USB 3.0 (or higher) ports

WARNING

The computer or notebook you use shall meet the safety requirements of IEC 60601-1 and IEC 60950.

4.3.2. Installing the software programs

The USB flash drive contains the IntraoralScan software program.



CAUTIONS

- Install the software programs in accordance with the instructions given here.
- When the installation is completed, do not plug the power adapter to the wall outlet or

turn on the scanner yet.

Follow the steps below to complete the installation of software programs:

- (1) Insert the supplied USB flash drive into the USB port of your computer
- (2) Find the file named IntraoralScanX.X.X.X.exe and run it as administrator.
- (3) The IntraoralScan InstallShield Wizard window appears to start the installation.
- (4) Specify a language from the drop-down list.
- (5) Click OK.
- (6) Follow the on-screen instructions to complete the installation.

When done, an icon named after DentalLauncher will be displayed on your desktop for quick access.

5. Setting the Scanner

5.1. Connecting the Scanner

CAUTIONS

- Ensure the supplied software programs are installed on your computer before the connection.
 - If the accuracy of the equipment decreases or if the equipment does not work properly, please consult technical support promptly.
 - Install the scanner in accordance with the instructions stated in the Manual.
 - Use the scanner only in dental laboratories, dental clinics, and equivalent environment.
 - Do not install, place, and use the scanner in dusty and damp environment or in the areas of temperature extremes or in direct sunlight.
 - Prepare a flat surface, e.g. your desk, for the scanner and the pedestal. Do not place them on a slanted surface.
 - Before the installation is completed, do not plug the power adapter into the wall outlet or turn on the scanner until you are instructed to do so.
 - Always hold the scanner firmly when lifting from the stand or when using the scanner. Do not shake the scanner.
 - Always return the scanner to the pedestal when it is not in use. Do not place the scanner in heated or wet surfaces as this can cause damage to the head and scanner.
 - It is normal that the scanner gets warm when in use. Do not block the ventilation holes on the bottom of the scanner. If the scanner overheats, the scanner will stop working.

WARNING

Ensure that you use only the supplied power adapter, power cable, and USB cable. Power supplies are supplied with connectors designed for this scanner. Do not connect any device other than this scanner.

Follow the steps below to complete the connection:

- (1) Make sure the scanner head is firmly attached to the front end of the scanner; otherwise, gently and firmly slide the scanner head onto the front-end of the scanner, as illustrated.
- (2) Insert the power plug of the supplied power adapter into the power connector on the pedestal, and plug the power adapter into a wall outlet.
- (3) Connect the scanner cable to the USB 3.0 upstream port on the pedestal.

(4) Connect the USB 3.0 downstream port on the pedestal and your computer with the supplied USB 3.0 cable.

(5) Turn on the power switch on the pedestal.

(6) Click the shortcut icon of IntraoralScan on the desktop to launch the software.

5.2. Disconnecting the Scanner



Do not attempt to directly disconnect the scanner by removing the power cable and USB cable.

Follow the steps below to safely disconnect the scanner:

(1) Quit the IntraoralScan scanning software.

(2) Disconnect the scanner USB 3.0 cable from the relay box.

(3) Disconnect the other port of the relay box from the computer.

(4) Right-click the “Safely Remove Hardware” icon on Windows taskbar and select “Eject Flash Drive”.

(5) Unplug the USB flash drive and keep it in a safe place for future use.

(6) Unplug the power adapter from the wall outlet and remove the power plug from the power connector on the pedestal.



Do not roll the cable over the handle of the scanner or even create any sharp bends in the cable after you disconnect the scanner. See USB cable storage in "4.2.3 Relay box" for more details.

5.3. Calibrating the Scanner

Under these circumstances, we recommend that you shall execute the calibration for the scanner to ensure the accuracy of scanned data:

- The initial setup of the scanner is completed.
- The scanner has been used for a period of time (e.g. 2 weeks).
- The scanner is accidentally dropped.
- Scanner brightness adjustment is recommended once every 3 months.
- The calibration plate inside the calibrator is a high-precision component, and the surface of the plate must be kept clean. If the calibration does not proceed smoothly, check the condition of the calibration plate surface. If you find a dirty surface, consult the manufacturer or the

authorized distributor.

Follow the steps below to perform the calibration:

(1) Insert the power plug of the supplied power adapter into the power connector on the pedestal, and plug the power adapter into a wall outlet.

(2) Connect the scanner cable to the USB 3.0 upstream port on the pedestal.

(3) Connect the USB 3.0 downstream port on the pedestal and your computer with the supplied USB 3.0 cable.

(4) Turn on the power switch on the pedestal.

The LED light ring on the end of the scanner body lights up green when the power connection is working properly.

(5) Hold the scanner head firmly with your thumb and forefinger on both sides, and then gently slide the head off from the scanner.



NOTES

- Do not place your finger(s) on the mirror of the head when detaching as this may result in damage to the mirror.

- Store the detached head in a safe place, e.g. a dental instrument tray, for future use.

(6) Connect the supplied Calibrator and your computer with the supplied USB 3.0 cable.

(7) Gently slide the Calibrator onto the front end of the scanner.



(8) Click calibration icon on the upper left corner of interface to display calibration interface.

Ensure the scanner is plugged into the calibrator firmly. Click **Start**. Calibration begins.

NOTE

Normally the calibration takes approximately 5 minutes.

(9) The message prompting successful calibration appears once the calibration is completed.

Click OK to exit.

(10) Gently slide the Calibrator off the scanner.



CAUTION

Make sure that the Calibrator is removed from the scanner after the calibration is done.

Otherwise, the Calibrator temperature may get very high.

(11) Reattach the scanner head to the scanner for later use or put the protection cap onto the scanner to prevent damage and dust.

6. Scanning Preparations

Read and follow the guidelines and heads given in this chapter prior to acquire quality images.

Warning

Concerning hand hygiene and personnel safety when performing a scan, you must wear clean surgical gloves through the whole process.

6.1. Intraoral Environment

- Make sure there is no foreign body or blood in the mouth after gargling. Stop the bleeding if necessary.
- If necessary, ask the patient to keep the tongue still and move it to the other side of the mouth.
- Consider using a dental three-way syringe to blow dry or a tampon to dry the tooth surface before starting the scan.
- Turn off the oral light on the dental chair and start scanning.
- Consider using aspirators and tampons to keep the surfaces dry during scanning.
- If necessary, consider using an oral mirror to help create space while working in the narrow area between the teeth.

6.2. Scanner Preparation

- Ensure that the scanner head, scanner body, and pedestal are properly pre-cleaned, disinfected, or sterilized. See Pre- cleaning, disinfection, and sterilization on chapter 10.
- Ensure that the scanner head has no scratches or is not damaged. Additionally, the head is firmly attached to the front end of the scanner body.
- Ensure that the scanner connection is ready; it is correctly connected to a power source and powered on, and IntraoralScan is launched and ready to work.
- To avoid condensation on the mirror of the head when scanning, the scanner head must have been warmed up. For details, see Heating the scanner head on chapter 5.
- Calibrate the scanner and verify the accuracy of the acquisition regularly. For details, see Calibrating the scanner on chapter 4.

6.3. Scanning Position and Path

- Avoid direct light from any light source, e.g. dentist chair lamp, to shine on the area you are working on.

- Hold the scanner steady by resting it on the tooth surface and keep the scanner head within 15 mm from the teeth.
- When scanning, slowly move the scanner and simultaneously check the scan results on the screen to ensure that the scanning is of good quality.
- When scanning, the scanner head should be centered over the teeth, and each movement should align with the cross-hairs, following the lower and upper dental arch shapes.
- A complete scan data of a single area includes the surfaces of occlusal, lingual, buccal, interproximal contacts of the adjacent teeth, and 2-3 mm buccal gingiva.
- A complete scan data of a single case includes the lower jaw, upper jaw, and bite registration.
- When scanning, change the scanning angle to 35-55 degrees in order to create overlaps. It is important to achieve an overlap of at least 30% between each acquisition. If the overlap is small, it may cause the alignment to fail.
- To scan the occlusal surface of the teeth, hold the scanner at a 90-degree angle; to scan the buccal and lingual surfaces of the teeth, hold the scanner at a 45-degree angle.
- Inspect the scanned image in the 3D scan view window (IntraoralScan) and pay attention to warning messages.

6.4. Heating the Scanner Head

To ensure optimal image quality, you should prevent condensation on the scanner mirror before each scan by heating the scanner head.

Follow the steps below to warm up the scanner before starting an acquisition:

- (1) Ensure that the scanner head, scanner body, and pedestal are clean. For details, see Pre-cleaning, disinfection, and sterilization on chapter 10.
- (2) Gently and carefully attach the scanner head to the scanner body, with the mirror facing downward.
- (3) Connect the power supply to the AoralScan 3. See Connecting the scanner in chapter 4.
- (4) Place the scanner in the pedestal to secure it in place.
- (5) When the LED ring light on the end of the scanner body lights up green, the heater automatically turns on and detects the temperature.

If the temperature of the scanner head is lower than the set point for anti-fogging, a notification message of pre-heating and current temperature appears.

When the message disappears, the warm-up is done. The scanner is now ready for an acquisition.



NOTES

- The heater maintains constant temperature on the scanner head.
- The scanner head is being heated whenever power is supplied, even if the scanner is in standby or sleep mode.
- If the heater does not reach the necessary temperature for preventing condensation during scanning, the message of “The scanner is pre- heating. Please wait” appears.

7. Clinical Case Quick Guide

Note:

This chapter takes clinical case as example to show software related operations. For more software related operations, see User Manual.

7.1. Connect the Scanner

See "5.1 Connecting the Scanner."

7.2. Activate the Scanner

When the scanner is first used, it must be connected to the internet and activated successfully. Double-click DentalLauncher icon on the desktop. The activation prompt interface is displayed.

Ensure the computer has been connected to the Internet, click "Yes" to activate the device, proceed to the next step after successfully activated. Otherwise, contact technical staff.

7.3. Calibration

See "5.3 Calibrating the Scanner." To ensure the quality of the scanned data, it is necessary to perform calibration periodically (every 15 days recommended).

7.4. Register Account

For users without cloud platform account, register account first. Click **New User? Click here to register**. The register interface is displayed. Select or enter user info. Mind that you need to select **Read and agree with it**.

7.5. Create Orders

On the New Order interface, create a new order or import a saved order.

Click **Create New Order**. Fill out the necessary order information, including the order number, names of dentist(s), patient, and lab(s).

Select the desired type of restoration and the tooth number (the restoration site), and then click **Save**.

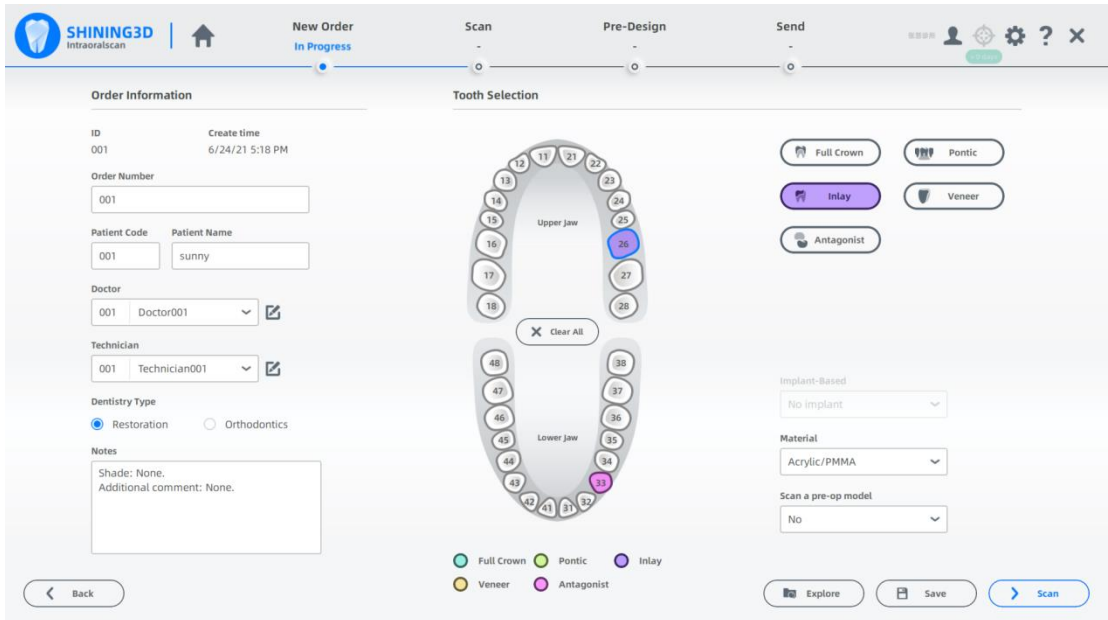



Click **Scan**. Scanning begins.

7.6. Scan Upper Jaw

Confirm that the image of the camera window in the upper right corner of the software is

displayed normally. Click the scan button  or press the space bar to start scanning.

Before scanning, click  in the right side and then it will turn to . The software will automatically remove the buccal and tongue side data during intraoral scanning. (images unable and enable AI optimization)

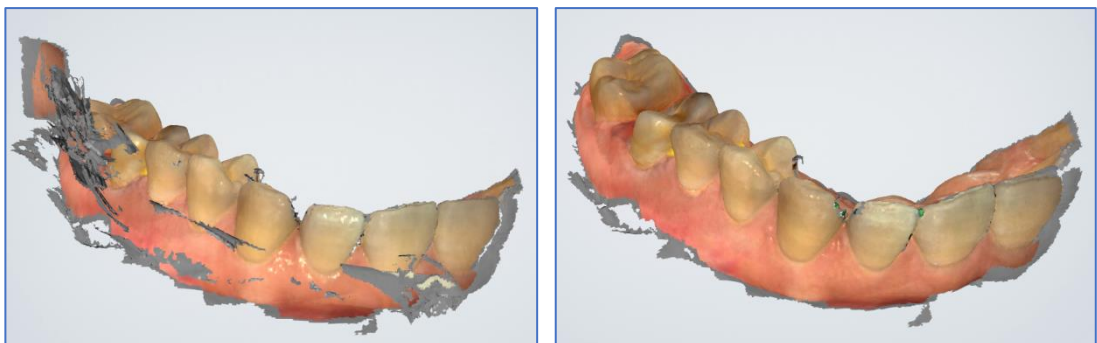

The green frame in the middle of the software interface indicates the data range of the current scanning. If the green frame changes to a red frame, as shown in the figure below, the scan position is incorrect. You need to move the scan head to scan the data displayed in the red frame.

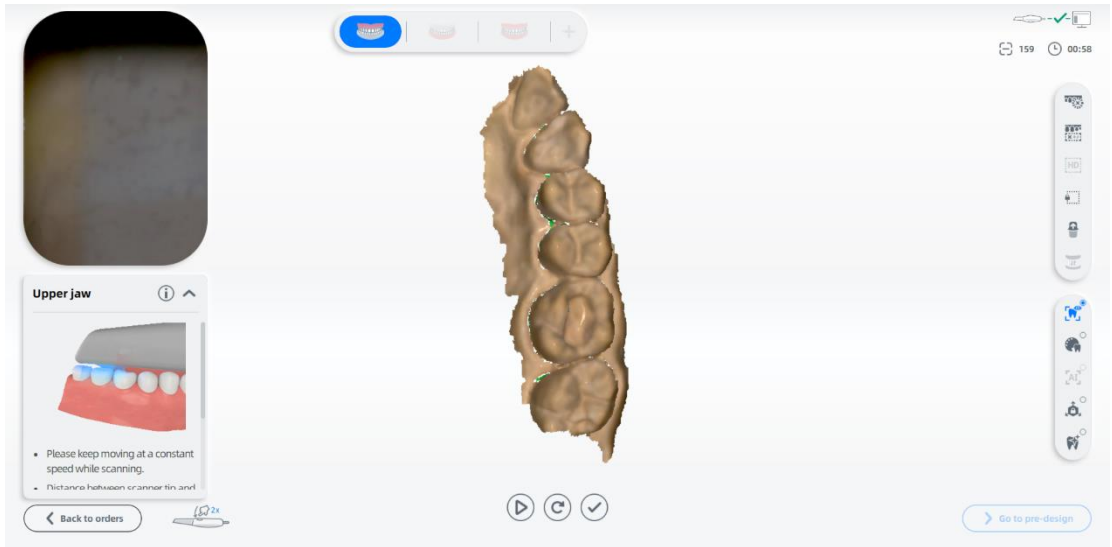

When the scanning head leaves the object or the scanning is paused, the green area means this area is not scanned. User can re-scan the corresponding area according to the demand.

Confirm that the model scan is complete. Click  or long press the space bar to process and save the data. After the completion, the upper jaw icon is green and ticked, indicating that the scanning process is finished.

7.7. Scan Lower Jaw

After the upper jaw scanning and the data processing are completed, the lower jaw scanning interface is automatically displayed. The procedure is the same as scanning the upper jaw.

7.8. Scan Total Jaws

After the lower jaw scanning and the data processing are finished, the total jaw scanning interface is automatically displayed.

Click  or press the space bar to start scanning. After scanning some data, the software automatically performs dynamic bite stitching alignment, as shown below.

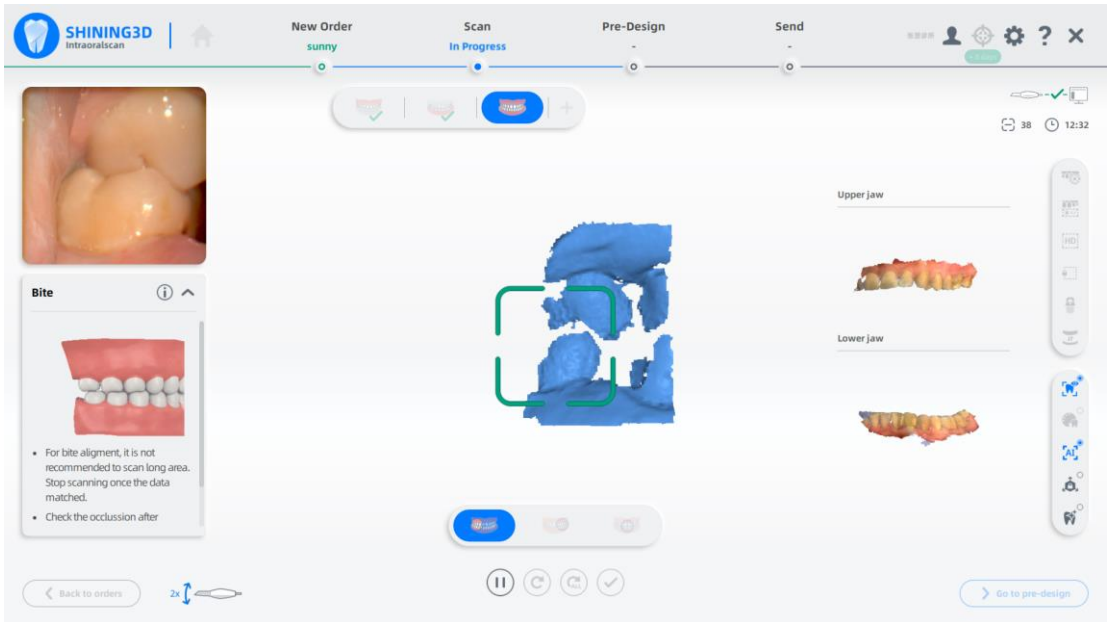

Before aligning

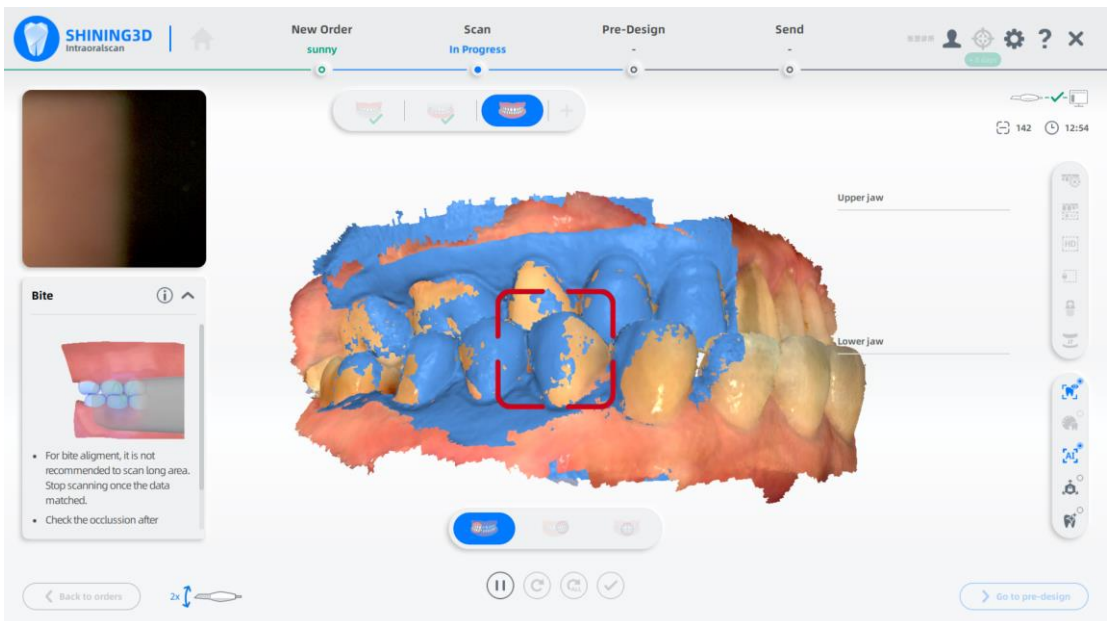



After aligning

After the upper and lower jaws' data are stitched successfully as well as the whole jaw, click

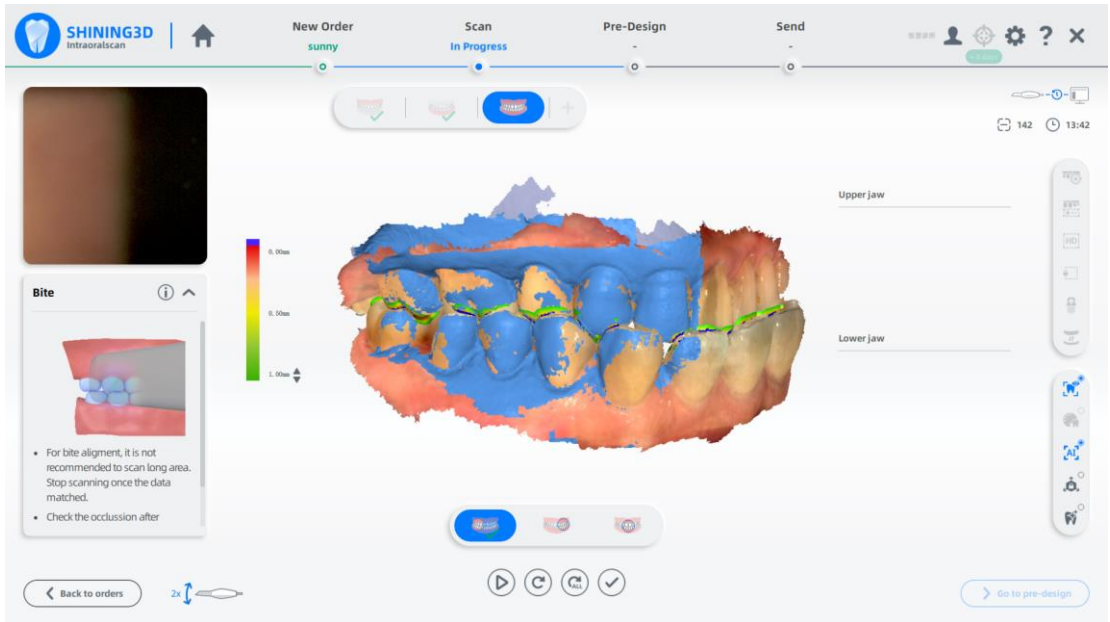

or press the space bar to pause the scanning, check the occlusion and collision results.



Click  or long press the space bar to post-process the data.

7.9. View Result Data

View result data in IntraoralScan.

7.9.1. View Upper/Lower Jaw

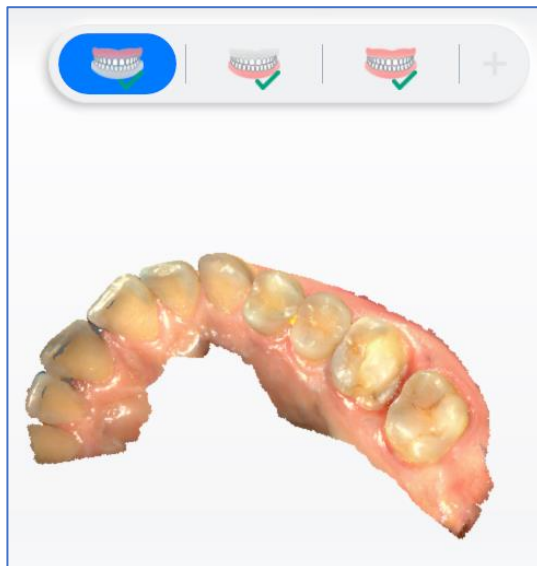

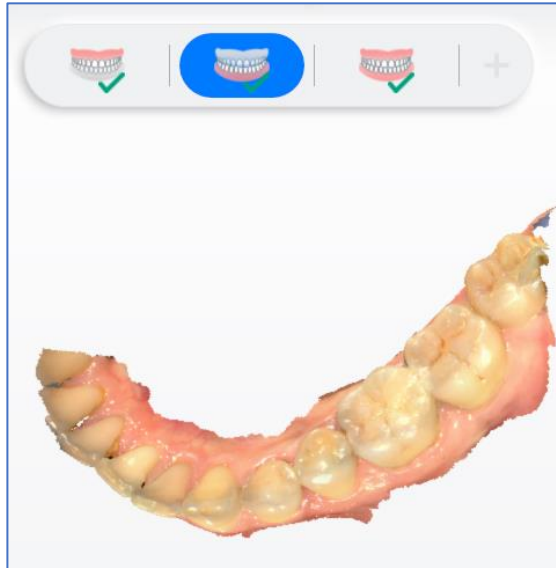

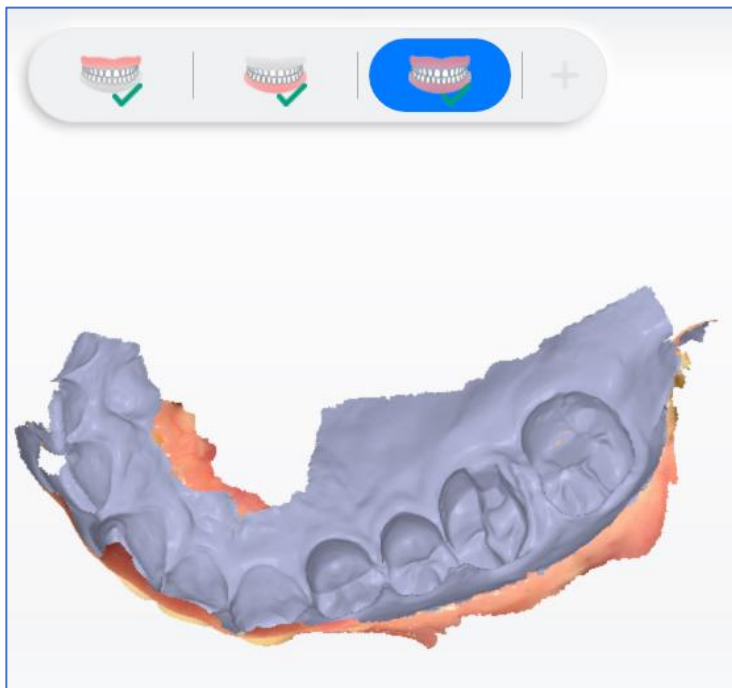

7.9.2. View Occlusal Effect

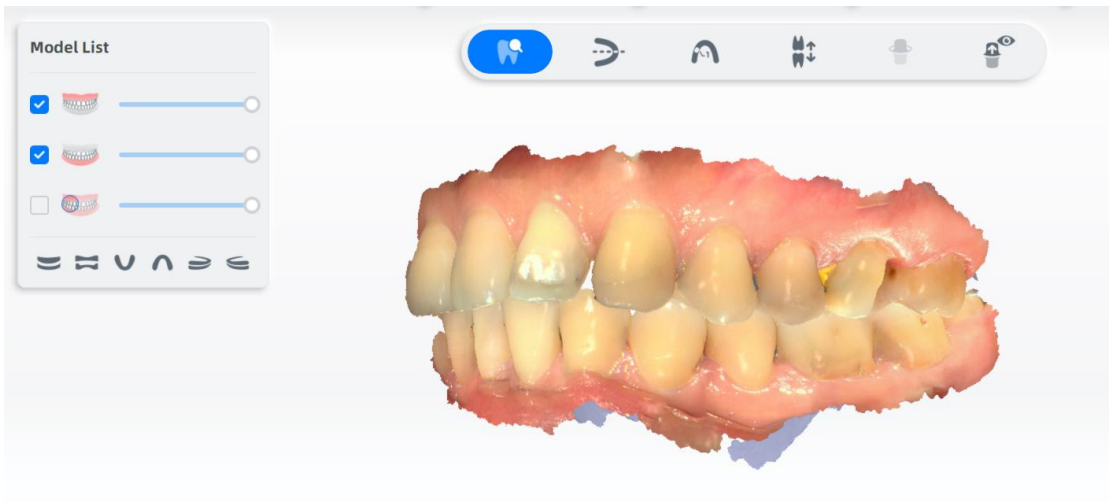

7.10. Pre-Design

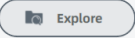

7.11. View Data Storage Path

Click  under **New Order** to return to the order interface and click  to open the folder path of the current order storage.

7.12. Upload Order

Click  to upload the scanned order.

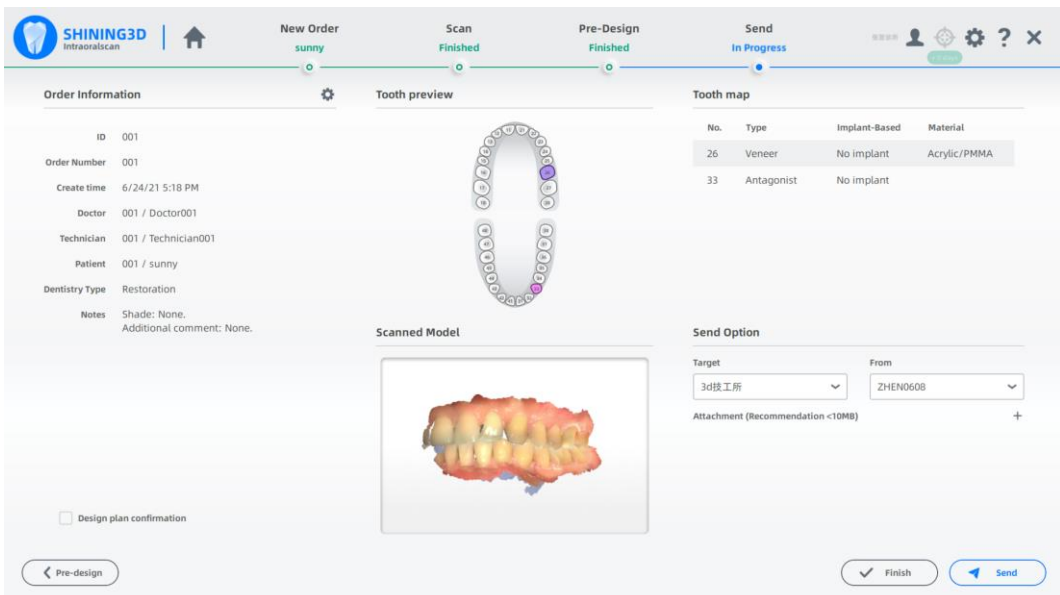

8. Care and Maintenance

8.1. Pre-cleaning, Disinfection, and Sterilization

The whole set of **Aoralscan 3**, including scanner head, scanner body, and scanner pedestal, requires proper care, cleaning, and handling. As individual part may be processed differently, read and follow the information and instructions given to help you effectively and thoroughly reprocess the set.

We suggest that you reprocess the **Aoralscan 3** in the following order:

- (1) Scanner pedestal care
- (2) Scanner body care
- (3) Scanner head care

WARNINGS

- All parts are shipped non-sterilized. Follow the instructions prior to initial use.
- Ensure that you have completely disconnected the power supply and all connections from the scanner.
 - Follow the instructions given in the Manual to pre-clean, disinfect, and sterilize each part of the scanner. Using other methods not approved by Shining3D Corporation will damage your scanner and void your warranty.
 - Using detergent, disinfection solutions or wipes, sterilization procedures other than those specified in the Manual may damage the product and void your warranty.
 - Only sterilize the part(s) for which a sterilization method is specified. Do not attempt to sterilize all parts of the product. Shining3D Corporation is not liable for any damages due to improper sterilization.
 - After sterilization, wait until each of the parts is at room temperature to prevent possible heat injuries to the user and the patient.
 - To prevent cross-contamination, pre-cleaning, disinfection, and sterilization must be correctly performed after each use.
 - When the scanner head is detached from the scanner, always protect the subtle units and the inner optical components on the front end of the scanner body by putting on the supplied protection cap.

8.2. Scanner Pedestal Care

The scanner pedestal requires an intermediate-level disinfection.

WARNINGS

- Concerning hand hygiene and personnel safety when performing pre- cleaning and disinfection/sterilization, you must wear clean surgical gloves before you start.
- Always ensure that you have pre-cleaned and disinfected/sterilized the scanner body, scanner pedestal, and scanner head before each scan.
- The caring methods for the scanner pedestal, scanner body, and scanner head are different and must be executed separately. After disinfecting the scanner pedestal, you may proceed with the scanner body and finally the Scanner head.
- Ensure that the scanner body is not placed in the pedestal prior to disinfecting the scanner pedestal.

Follow the steps below to complete the disinfection:

- (1) Disconnect the power of the **Aoralscan 3** (see Disconnecting the scanner on chapter 4).
- (2) Hold the pedestal firmly with your hand.
- (3) Use new cotton gauze moistened with 70%-75% solution of ethanol to wipe the surface of pedestal.



Avoid using detergent of any kind as some detergents or surfactants might penetrate into the surface of the pedestal.

- (4) When done, store the pedestal in a clean and safe place.
- (5) Proceed to the disinfection of the scanner body (see Scanner body care on chapter 10).

8.3. Scanner Body Care

The scanner body requires an intermediate-level disinfection.

WARNINGS

- Concerning hand hygiene and personnel safety when performing pre- cleaning and disinfection/sterilization, you must wear clean surgical gloves before you start.
- Always ensure that you have pre-cleaned and disinfected/sterilized the scanner body, scanner pedestal, and scanner head before each scan.
- The caring methods for the scanner pedestal, scanner body, and scanner head are different and must be executed separately. Before disinfecting the scanner body, you shall start

with the pedestal first.

- Ensure that the scanner head is detached from the scanner, and the protection cap is put on the scanner when disinfecting the scanner body.

Follow the steps below to complete the disinfection:

(1) Disconnect the power of the **Aoralscan 3** (see Disconnecting the scanner on chapter 4).

(2) Hold the scanner head firmly with your thumb and forefinger on both sides, and then gently slide the head off from the scanner, as illustrated.



NOTE

Do not place your finger(s) on the mirror of the head when detaching as this may result in damage to the mirror.

(3) Store the detached head in a safe place, e.g. a dental instrument tray, prior to disinfecting the scanner body.

(4) Hold the supplied protection cap with the triangle mark facing upward. Then, align the protection cap blocks to the matching slots on the front end of the scanner body.

(5) Slide the protection cap onto the scanner to prevent damage and dust.

CAUTIONS

- When the scanner head is detached, always protect the subtle units and the inner optical components on the front end of the scanner by putting on the supplied protection cap.

- Do not attempt to clean the outer units and inner optical components on the front end of the scanner with any sharp objects or other such tools, which may result in scratches and damage to the scanner.

(6) Hold the scanner body with your hand.

(7) Use new cotton gauze moistened with 70%-75% solution of ethanol to wipe the surface of scanner body.

CAUTIONS

- Avoid using detergent of any kind as some detergents or surfactants might penetrate into the surface of the scanner body.

- Do not clean the intake and exhaust vents with any sharp objects or other such tools.

(8) When done, store the scanner body in a clean and safe place.

(9) Proceed to the cleaning, disinfection or sterilization of the scanner head.

8.4. Scanner Head Care

The scanner head is the most essential part of the scanner as it is inserted into your patient's mouth during scanning. Therefore, the head must be thoroughly cleaned and sterilized before and after each patient contact in order to prevent cross- contamination in your operation.

WARNINGS

- Concerning hand hygiene and personnel safety when performing cleaning and disinfection/sterilization, you must wear clean surgical gloves and goggles before you start.
- Always ensure that you have pre-cleaned and disinfected/sterilized the scanner body, scanner pedestal, and scanner head before each scan.
- The caring methods for the scanner pedestal, scanner body, and scanner head are different and must be executed separately.
- Cleaning the scanner head is an essential step before effective disinfection or sterilization.
- When inserting the scanner head into the disinfectant solution, be sure to follow the instructions on the disinfectant label and limit the time and depth that the head is soaked within the minimum time recommended.
- The scanner head can be sterilized under high temperature up to 100 times and must be disposed of afterwards. For more information on disposal, see Disposal on chapter 1.
- High-level disinfection and steam sterilization must NOT be combined.
- Apply only either of these methods to ensure the safe and effective reprocessing of the scanner head, and thus to prevent damage of reusable head.

Two effective and approved methods of cleaning and disinfection/ sterilization are recommended and described as below.

Either should be used to reprocess the scanner head between each patient contact:

8.4.1. Cleaning and high-level disinfection

Follow the steps below to perform cleaning and high-level disinfection:

- (1) Disconnect the power of the **Aoralscan 3** (see Disconnecting the scanner on chapter 4).
- (2) Hold the scanner head firmly with your thumb and forefinger on both sides, and then gently slide the head off from the scanner body.

CAUTION

Do not place your finger(s) on the mirror of the head when detaching as this may result in damage to the mirror.

(3) Hold the supplied protection cap with the triangle mark facing upward. Then, align the protection cap blocks to the matching slots on the front end of the scanner body.

(4) Slide the protection cap onto the scanner to prevent damage and dust.

(5) Pay particular attention to inspect the mirror of the head to ensure that the mirror is not cracked or broken and there is no scratch on it.



If the mirror of the head has cracks or scratches, stop the cleaning process and contact your local distributor or service provider.

(6) Gently clean the inner and outer sides of the head using mild pH-neutral soap water and a soft brush for 3 minutes.

- When cleaning the inner surface of the head, insert the soft brush into the head from both the front and rear ends, and move the brush lightly in tiny circles.

- When cleaning the outer surface of the head, move the brush lightly back and forth, and repeat for each side.

(7) Repeat the previous step for at least two times.

(8) Rinse the head thoroughly with sterile water for at least 3 minutes.

(9) If you notice stains, fingerprints, or smears on the mirror surface, repeat the previous step.

(10) Dry the head carefully with a clean, soft lens tissue or lint-free cloth.

(11) Pay particular attention to inspect the mirror surface of the head again to make sure that the cleaning is done properly and the mirror is not damaged during the cleaning process.

(12) Carefully fill the container with a disinfectant solution, such as phthalaldehyde at a concentration of 5.5g/L (depending on the brand of disinfectant used). In the event of a leak, follow the disinfectant manufacturer's instructions for handling.

(13) Immerse the cleaned head into the disinfectant and leave it for at least 12 minutes at 25°C.



(14) Prepare a large container of sterile water, e.g. 2 L.

(15) Take out the head from the disinfectant.

(16) Immerse the head into the container of sterile water for at least 5 minutes.

(17) Take out the head and manually flush it with at least 500 ml of sterile water.

CAUTION

Discard the rinse water. Always use fresh volumes of sterile water for each rinse. Do not reuse the water for rinsing or any other purpose.

(18) Repeat the rinsing process (step 14 to 17) for at least two times for removing the residue of disinfection solution.

(19) Use a soft lint-free cloth to dry the head.

(20) Pay particular attention to inspect the mirror surface of the scanner head again to make sure that the disinfection is done properly and the mirror is not damaged during the disinfection process.

(21) Re-attach the scanner head (see Attaching the scanner head on chapter 10). Or if you attempt to store the scanner head with other dental instruments, e.g. a dental instrument tray, ensure that it is thoroughly dry.

8.4.2. Cleaning and steam sterilization

Follow the steps below to perform cleaning and steam sterilization:

(1) Disconnect the power of the **Aoralscan 3** (see Disconnecting the scanner on chapter 4).

(2) Hold the scanner head firmly with your thumb and forefinger on both sides, and then gently slide the scanner head off from the scanner, as illustrated.



Do not place your finger(s) on the mirror of the head when detaching as this may result in damage to the mirror.

(3) Hold the supplied protection cap with the triangle mark facing upward. Then, align the protection cap blocks to the matching slots on the front end of the scanner body.

(4) Slide the protection cap onto the scanner to prevent damage and dust.

(5) Pay particular attention to inspect the mirror of the head to ensure that the mirror is not cracked or broken and there is no scratch on it.



If the mirror of the head has cracks or scratches, stop the cleaning process and contact your local distributor or service provider.

(6) Gently clean the inner and outer sides of the head using mild pH-neutral soap water and a soft brush for 3 minutes.

- When cleaning the inner surface of the head, insert the soft brush into the head from both the front and rear ends, and move the brush lightly in tiny circles.
- When cleaning the outer surface of the head, move the brush lightly back and forth, and repeat for each side.

(7) Repeat the previous step for at least two times.

(8) Rinse the head thoroughly with sterile water for at least 3 minutes.

(9) If you notice stains, fingerprints, or smears on the mirror surface, repeat the previous step.

(10) Dry the head carefully with a clean soft lens tissue or lint-free cloth.

(11) Pay particular attention to inspect the mirror surface of the scanner head again to make sure that the cleaning is done properly and the mirror is not damaged during the cleaning process.

(12) Wrap the cleaned head with a cloth cautiously.

(13) Put the packaged scanner head into an autoclave and sterilize it for 30 minutes at 121°C (or 4 minutes at 134°C). For the specific sterilization pressure, refer to the instructions of the autoclave (102.9kpa at 121°C is recommended; Or 205.8kPa at 134°C).

(14) Dry the sterilized head for 30 minutes with the autoclave program before opening the autoclave.

(15) Re-attach the scanner head.

8.4.3. Attaching the scanner head

There is a risk of damaging the mirror of head if any improper actions are taken when attaching the head to the scanner.

WARNINGS

- Wear clean surgical gloves before you start.
- Ensure that the scanner pedestal, scanner body, and scanner head are pre-cleaned and disinfected/sterilized (see Scanner body care on chapter 10 and Scanner storage on chapter 10).

Follow the steps below to complete the attachment:

- (1) Hold the scanner head firmly with your thumb and forefinger on both sides, and then gently attach the head facing downward to the scanner.



CAUTION

Do not place your finger(s) on the mirror of the head when attaching as this may result in damage to the mirror.

- (2) Try swiveling the scanner head around to ensure it is locked into position and stable.
- (3) Place the scanner in the pedestal, and the set is ready for use.

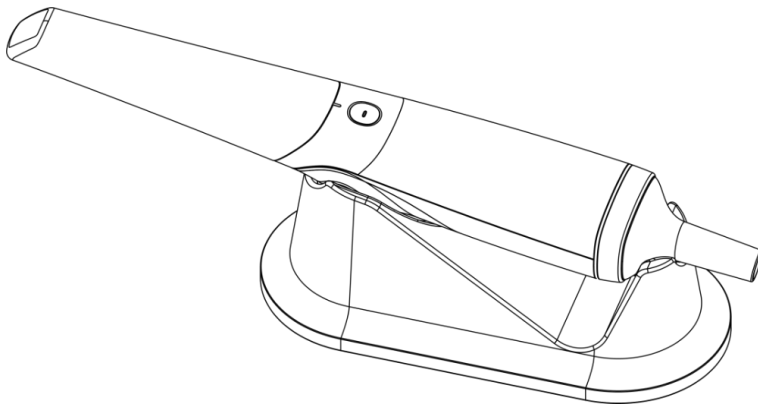

8.5. Scanner Storage

In case you need to transport the device, we strongly recommend that you keep the original packaging after unpacking your **Aoralscan 3**. Shipping the device without its original packaging material may cause possible product damage and result in additional service fees.

For information on temperature and humidity requirements, see “Environmental requirements on chapter 10”.

If the original packaging is no longer available or damaged, carefully package each part of the scanner with bubble wrap to protect against any possible damage during transportation.

8.5.1. Storage for Transport

- Make sure that the scanner is clean before placing it in the original carry box/package to avoid any possible contamination.
- Place each part of the product, e.g. the head, scanner body, pedestal, power adapter, in the original package carefully and prevent kinks of the cable.
- Make sure that each cable is rolled up and tangle-free before placing it in the original

carry box.

- Before closing the lid, make sure no part of the product is protruding from the package.

8.5.2. Daily and Long-term Storage

- Always place the scanner in the pedestal when it is not in use.
- When the scanner head is detached from the scanner body, always protect the subtle units and the inner optical components on the front end of the scanner by putting on the supplied protection cap.

- Ensure the scanner is clean before long-term storage.
- Avoid storing the scanner and accessories in areas of extreme temperatures or under direct sunlight.

- Before storing the scanner, make sure the scanner head, scanner body, and pedestal are thoroughly dry.

9. Hardware Specification

9.1. Specifications

Type name	Intraoral Scanner
Model name	Aoralscan 3
Scanner	
Scan field	Standard scanner head: 16 mm × 12 mm × 17 mm Small scanner head: 12 mm × 9 mm × 17 mm
Scan theory	Non-contact scanner with the structured light
Dimension (L × W × H)	281 mm × 33 mm × 46 mm
Weight	240 ± 10 g (without cables)
Output	STL, OBJ, PLY
Connector	USB 3.0
Power	Input: 12V DC/3 A
Pedestal	
Dimension (L × W × H)	146 mm × 82 mm × 86 mm
Weight	400 ± 10 g
Product life	8 years

9.2. Environmental Requirements

Operating and storage requirements

- Operating temperature: 10°C–40°C
- Storage/Transport temperature: -25°C–60°C
- Operating altitude: < 3000 M
- Storage/Transport/Relative humidity: 30%–75%
- MTBF: 10,000 hours (except DMD/LED)
- Air pressure: 86 kPa–106 kPa